

Transformers 1-phase

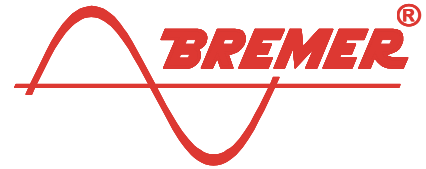

"EI" transformers 4 to 550VA in horizontal construction with spacers. Compact construction for units that allow screwing through from the back of the mounting plate. Space-saving, with free ends or solder lugs.

BREMER 1520-en

Design:	Horizontal with spacer bolts	Ambient temperature:	ta = 50°C (ta = 50/B)
Type series:	"EI" - horizontal	Temperature rise:	ΔT = ca. 40...50K (50/B)
Terminals:	According to customer requirements	Core material:	Standard material

Core-Type	Power approx. VA	Insulating class	Weights copper / total kg	Dimensions without terminals			Mounting dimensions	
				Width B mm	Depth T mm	Height H mm	C x D mm	For screw
EI 42/14,8	4	B	0,1 / 0,3	42	35	35	35 x 28	M 3
EI 42/20	7	B	0,1 / 0,4	42	35	40	40 x 32	M 3
EI 48/16,8	9	B	0,1 / 0,4	48	40	43	40 x 32	M 3
EI 54/18,8	v 14	B	0,1 / 0,5	54	45	40	45 x 36	M 3
EI 60/21	v 18	B	0,1 / 0,5	60	50	55	50 x 40	M 3
EI 60/25,5	v 22	B	0,1 / 0,6	60	50	60	50 x 40	M 3
EI 60/31	v 27	B	0,1 / 0,6	60	50	65	50 x 40	M 3
EI 66/23	27	B	0,1 / 0,7	66	55	55	55 x 44	M 3
EI 66/34,5	37	B	0,1 / 0,9	66	55	65	55 x 44	M 3
EI 78/27,5	v 47	B	0,2 / 1,1	78	65	70	65 x 52	M 4
EI 78/36,5	v 60	B	0,3 / 1,4	78	65	80	65 x 52	M 4
EI 84/29,5	63	B	0,3 / 1,4	85	70	70	70 x 56	M 4
EI 84/43,5	82	B	0,3 / 2,0	85	70	85	70 x 56	M 4
EI 96/35,7	v 100	B	0,4 / 2,3	96	80	80	80 x 64	M 4
EI 96/45,7	120	B	0,5 / 2,8	96	80	90	80 x 64	M 4
EI 96/59,7	140	B	0,6 / 3,5	96	80	105	80 x 64	M 4
EI 105/37,5	v 135	B	0,8 / 3,2	105	87,5	90	87,5 x 70	M 4
EI 105/45,5	v 150	B	0,8 / 3,5	105	87,5	95	87,5 x 70	M 4
EI 105/60,5	160	B	0,9 / 4,6	105	87,5	110	87,5 x 70	M 4
EI 120/41,7	v 190	B	1,0 / 4,1	120	100	95	100 x 80	M 5
EI 120/53,7	v 230	B	1,1 / 5,1	120	100	110	100 x 80	M 5
EI 120/61,8	v 250	B	1,1 / 5,7	120	100	115	100 x 80	M 5
EI 120/73,7	u 270	B	1,2 / 6,6	120	100	130	100 x 80	M 5
EI 135/52	u 300	B	1,7 / 6,6	135	112,5	110	112,5 x 90	M 5
EI 135/62	u 340	B	1,9 / 7,7	135	112,5	120	112,5 x 90	M 5
EI 135/72	u 385	B	2,1 / 8,8	135	112,5	130	112,5 x 90	M 5
EI 150N/49,6	v u 350	B	1,8 / 8,5	150	125	110	125 x 100	M 6
EI 150N/66,6	v u 440	B	2,0 / 10,5	150	125	126	125 x 100	M 6
EI 150N/92,6	v u 550	B	2,4 / 13,8	150	125	153	125 x 100	M 6

v = Preferred type u = Alternative types for these ratings available in type series UI (BREMER 1530-en)

Insulation class / highest final temperature according to IEC60085: B = 130°C F = 155°C H = 180°C

More about temperatures, standards, no-load / load behaviour, insulating materials and insulating material classes under Technical Terms

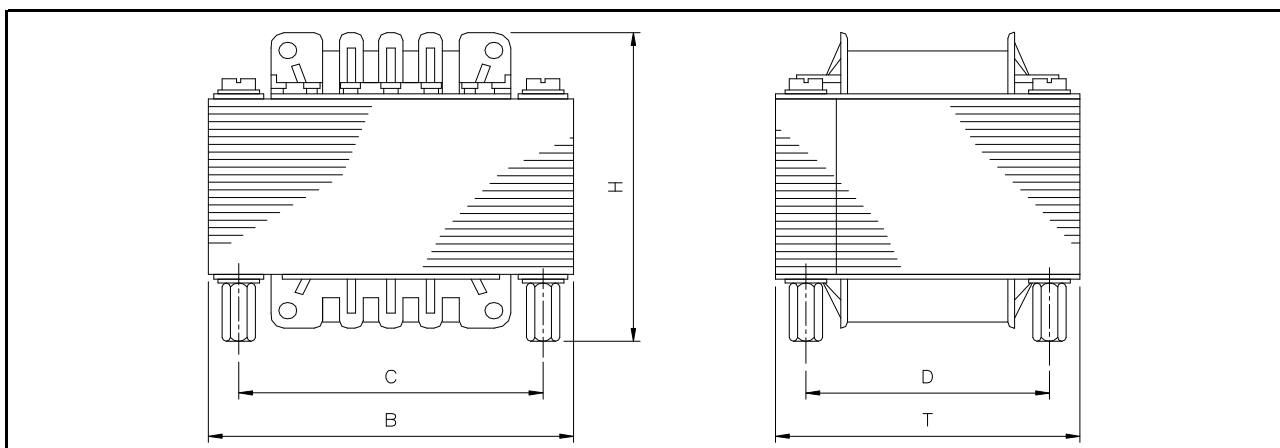

Error and subject to change

We develop and produce only in Germany / Berlin-Ludwigsfelde

© BREMER Transformatoren GmbH

Status: 27.09.2021 15:27

Table: BREMER 1520-en-dt_1EI-LA-FE-L_b.xls

Sketch: 1EI-LA-FE-L-aax-RF050519.dwg

BREMER Transformatoren GmbH

Feel free to call us: Phone +49 (0)3378 20 06-0

www.bremer-trafo.de info@bremer-trafo.de