

Transformers 3-phase

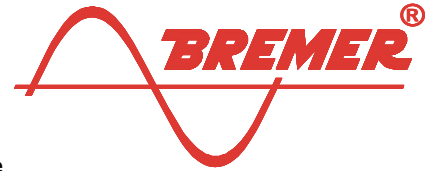

3-phase transformers 25 bis 600VA in horizontal construction with spacers.
Compact construction for units that allow screwing through from the back of the mounting plate. Space-saving, with free ends or solder lugs.

BREMER 3730-en

Design:	Horizontal with spacer bolts	Ambient temperature:	ta = 70°C (ta = 70/B)
Type series:	"Small" three-phase transformers	Temperature rise:	ΔT = ca. 25...30K (70/B)
Terminals:	According to customer requirements	Core material:	Loss reduced cores

Core-Type	Power approx. VA	Weights copper / total kg	Dimensions without terminals			Mounting dimensions	
			Width B mm	Depth T mm	Height H mm	C x D mm	For screw
3UI 48/17	25	0,4 / 1,0	96	40	80	64 x 64	M4
3UI 48/26	35	0,5 / 1,5	96	50	80	64 x 64	M4
3UI 60/21	60	0,6 / 2,0	120	55	100	80 x 80	M4
3UI 60/31	70	0,8 / 3,0	120	65	100	80 x 80	M4
3UI 75/26,5	160	1,5 / 4,5	150	65	125	100 x 100	M5
3UI 75/41,5	185	1,8 / 6,0	150	80	125	100 x 100	M5
3UI 90/31,5	260	2,4 / 7,0	180	75	150	120 x 120	M6
3UI 90/41,5	320	2,7 / 9,0	180	83	150	120 x 120	M6
3UI 90/51,5	370	3,0 / 10,5	180	93	150	120 x 120	M6
3UI 102/36	400	4,2 / 11,0	205	85	170	136 x 136	M6
3UI 102/46,5	470	4,7 / 13,5	205	95	170	136 x 136	M6
3UI 102/57	600	5,1 / 16,0	205	105	170	136 x 136	M6

Tell us your wishes for the connections!

Small horizontal 3-phase transformers with terminals see BREMER 3431, 3531 and 3731.

For 3-phase transformers of higher power in horizontal design see BREMER 3432, 3434; 3532, 3534; 3732, 3734;

For versions for ta 40°C see BREMER 34xx .

For versions for ta 50°C see BREMER 35xx .

For vertical versions see BREMER 3411 to 3414, 3511 to 3514 and 3711 to 3714.

Insulation class / highest final temperature according to IEC60085: B = 130°C F = 155°C H = 180°C

More about temperatures, standards, no-load / load behaviour, insulating materials and insulating material classes under Technical Terms

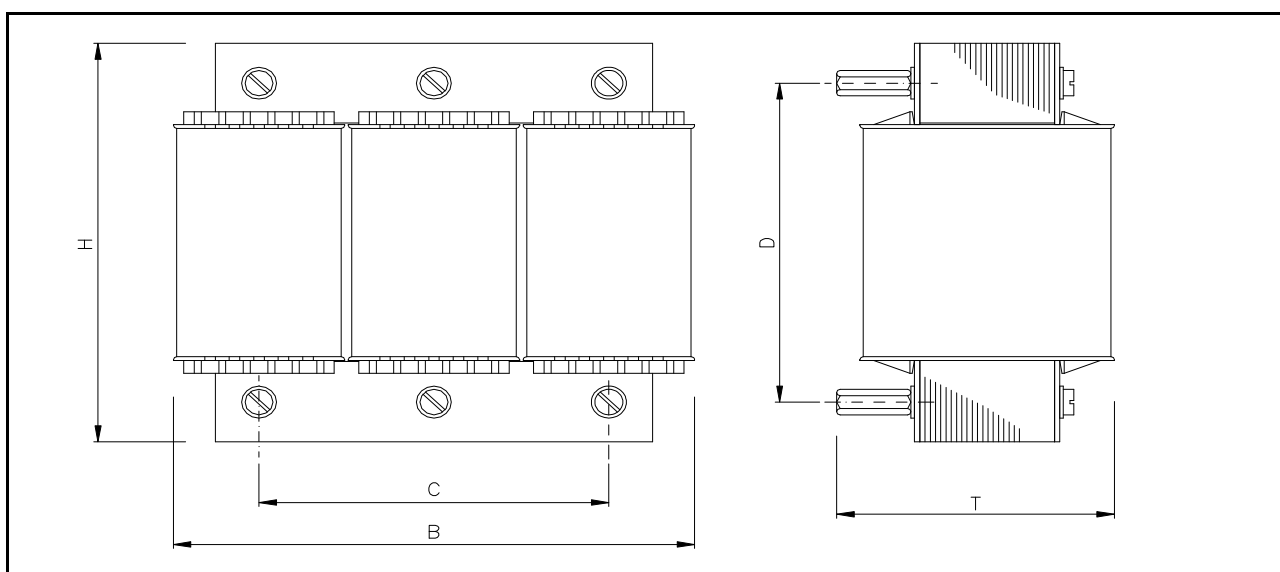

Error and subject to change

© BREMER Transformatoren GmbH

Status: 14.10.2021 18:10

Table: BREMER 3730-en-dt_kleine3UI-LA-FE__b.xls

Sketch: 3UI-LA-FE-aax-RF050519.dwg

We develop and produce only in Germany / Berlin-Ludwigsfelde

BREMER Transformatoren GmbH

Feel free to call us: Phone +49 (0)3378 20 06-0

www.bremer-trafo.de info@bremer-trafo.de